

HP Cluster Platform 4000, Two Cabinets, Gigabit Ethernet, 64x ProLiant DL145 Opteron 2.4GHz

HP Unified Cluster Platform 4000 Planning Template
 -Two Racks
 -Giga Ethernet
 -Opteron

#1 Utility Cabinet, 26 nodes in use (max32)

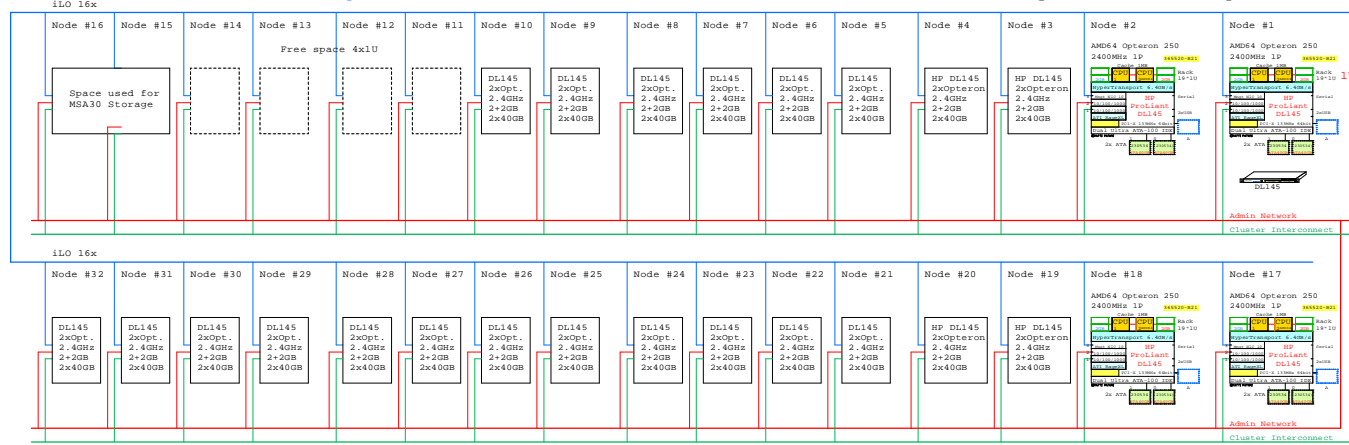

#1 Compute Cabinet, max 38 nodes in use.

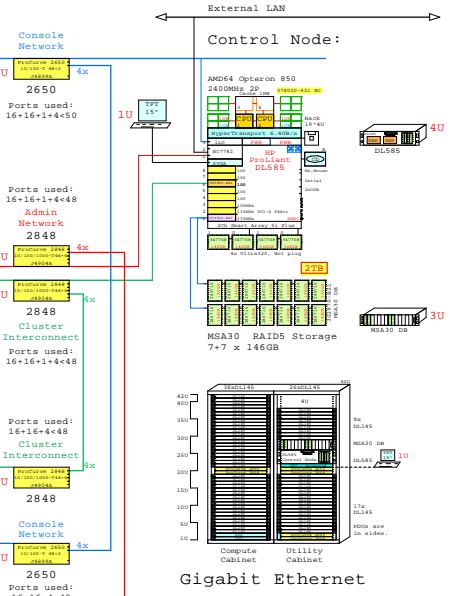
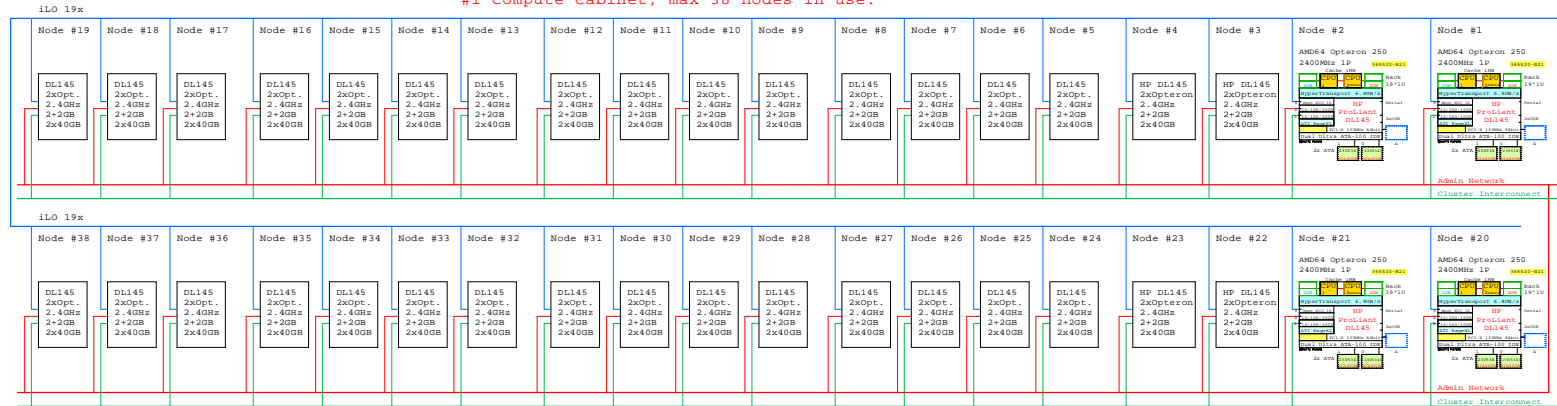

BOM for Optional Storage

Part Number	Qty	Description
1	1	MSA1000 RAID Array 256MB Rack 4U
1.1	3	MSA30 Dual Bus Ultra320 7*7 1"
1.1.1	4	30GB 10000r U320 disk 1"
1.2	4	30GB 10000r U320 disk 1"
2	1	MSA30 Single Bus Ultra320 14x1"
2.1	5	30GB 10000r U320 disk 1"
3	1	HBA 2Gb/s PCI PC2A214 for Linux

BOM for one Compute Node DL145

Part Number	Qty	Description
1	1	HP ProLiant DL145 LP 2.4GHz 2GB 40GB ATA
1.1	1	Smart Array 640713B Ultra320 2-channel
1.2	1	NC7773 PCI-X 10/100/1000-T Server Adapter
1.3	4	146.8GB 15000r U320 disk 1"
1.4	2	PC2700 1GB DDR SDRAM DIMM kit 2x512MB

BOM for the Control Node DL585, Storage and Switches

Part Number	Qty	Description
1	1	HP ProLiant DL585 2.4GHz 1MB 2GB 2P AMD6
1.1	1	Smart Array 640713B Ultra320 2-channel
1.2	1	NC7773 PCI-X 10/100/1000-T Server Adapter
1.3	4	146.8GB 15000r U320 disk 1"
1.4	2	PC2700 1GB DDR SDRAM DIMM kit 2x512MB
2	1	MSA30 Dual Bus Ultra320 7*7 1"
2.1	14	146.8GB 10000r U320 disk 1"
3	2	ProCurve 2650 10/100-T 48+250 Port 1U
4	4	ProCurve 2848 10/100/1000-T 44+448 Port

Optional Storage

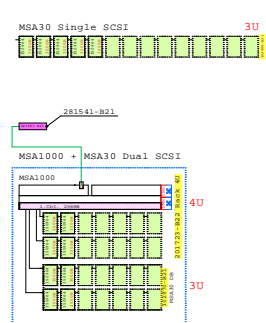

Compute and Control Node Options

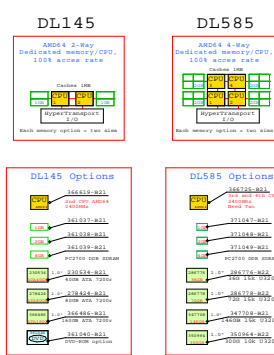

Nodes: AMD64 Opteron

Console Network

Control Node:

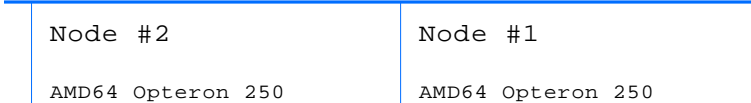
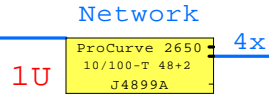
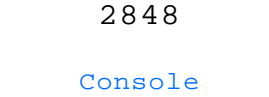
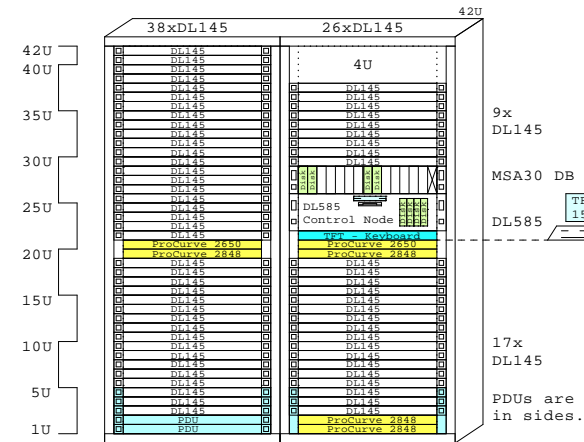
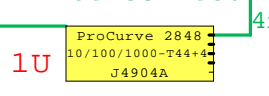
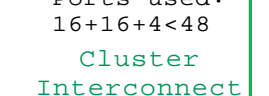
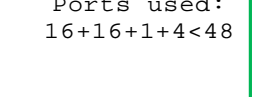
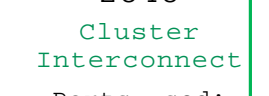
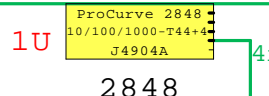
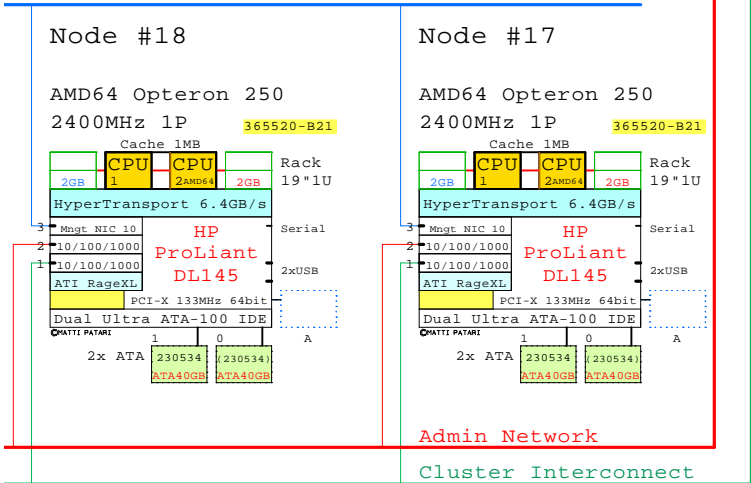
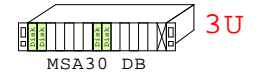
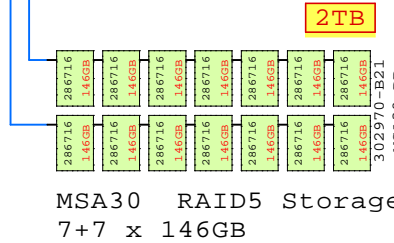
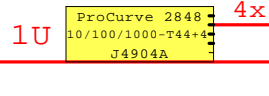
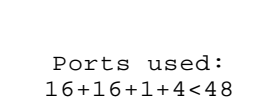
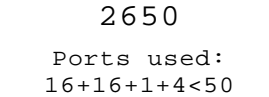
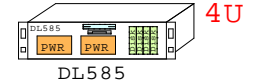
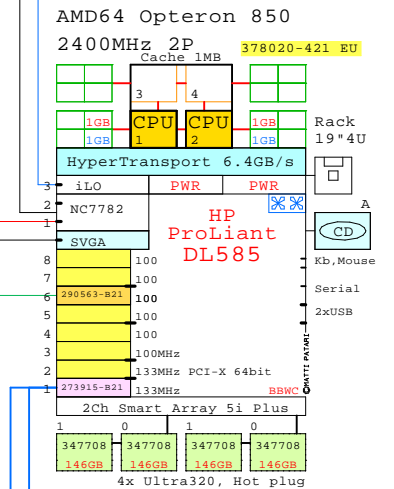
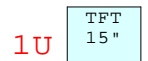
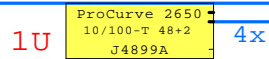
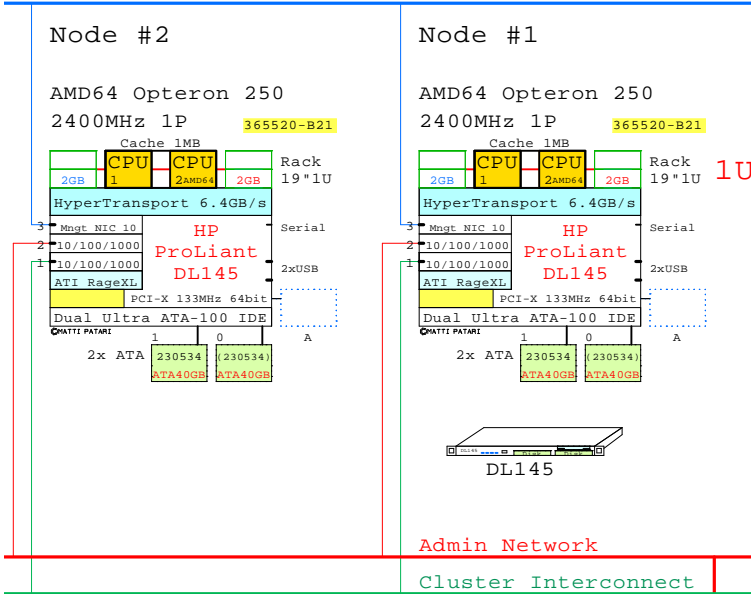

Compute Cabinet Utility Cabinet

Gigabit Ethernet

Optional Storage

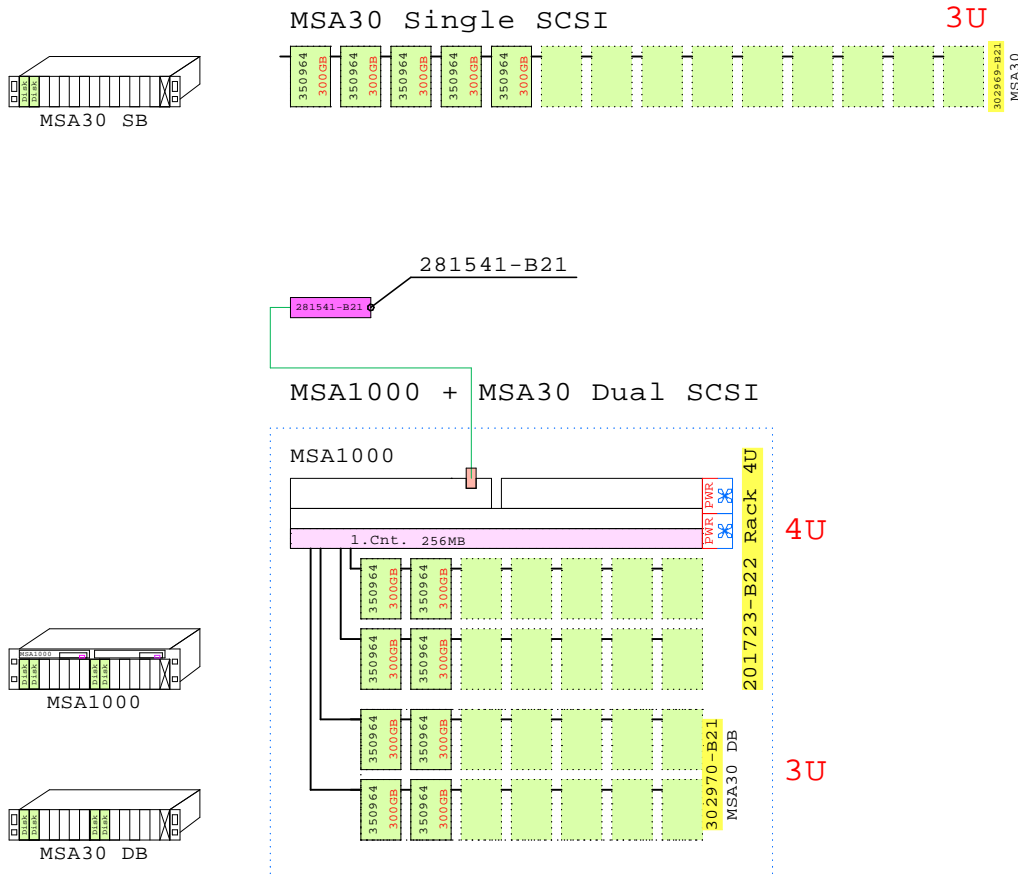

Compute and Control Node Options

DL145

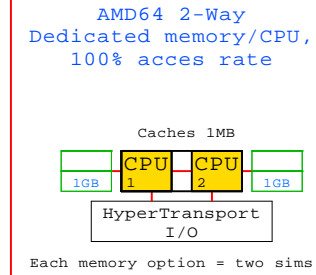

DL585

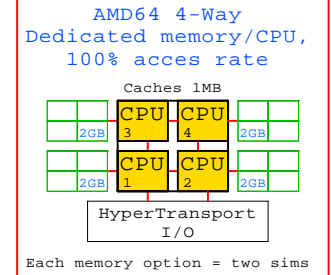

DL145 Options

- CPU AMD64:** 366619-B21 (2nd CPU AMD64 2400MHz)
- 1GB:** 361037-B21
- 2GB:** 361038-B21
- 4GB:** 361039-B21 (PC2700 DDR SDRAM)
- ATA40GB:** 230534 1.0* 230534-B21 (40GB ATA 7200r)
- ATA80GB:** 278424 1.0* 278424-B21 (80GB ATA 7200r)
- ATA160GB:** 266486 1.0* 366486-B21 (160GB ATA 7200r)
- DVD:** 361040 361040-B21 (DVD-ROM option)

DL585 Options

- CPU AMD64:** 366725-B21 (3rd and 4th CPU 2400MHz, Need Two)
- 1GB:** 371047-B21
- 2GB:** 371048-B21
- 4GB:** 371049-B21 (PC2700 DDR SDRAM)
- 36GB:** 286776 1.0* 286776-B22 (36G 15k U320)
- 72GB:** 286778 1.0* 286778-B22 (72G 15k U320)
- 146GB:** 347708 1.0* 347708-B21 (146GB 15k U320)
- 300GB:** 350964 1.0* 350964-B22 (300G 10k U320)