

HP ProLiant ML370 G5

Internal Options:

- 458412-B21
CPU Quad EM64T
2nd Quad-Core E5440
2830MHz 2x6MB
- 397409-B21
1GB
- 397411-B21
2GB
- 397413-B21
4GB
- 397415-B21
8GB
- 403766-B21
DDR2-SDRAM
2x DIMMs each
2nd Memory module
- 399771-B21
G5 2nd power
- 400693-B21
Blower kit ML370G5
- 431933-B21
36GB 15k SAS
- 431935-B21
72GB 15k SAS
- 431958-B21
146GB 10k SAS
- 367047-B21
NC320T 1000T
PCI-E Gigabit
- 414126-B21
NC510F One Port
PCI-E 10-Gigabit
- A8003A
FibChan PCI-E HBA
2ch 4Gb FC2242SR
- 273915-B21
Smart Array PCI-X
6402/128 2-ch
- 405132-B21
SA P400/256 PCI-E
- 401415-B21
2nd Drive Gage

- 403724-B21
x8
To convert two x4
to one x8 Express

400899-B21 ML370-G5 Rack kit

Example Configuration

Intel Xeon E5440 EM64T
2830MHz 1P-Q 458344-421 EU

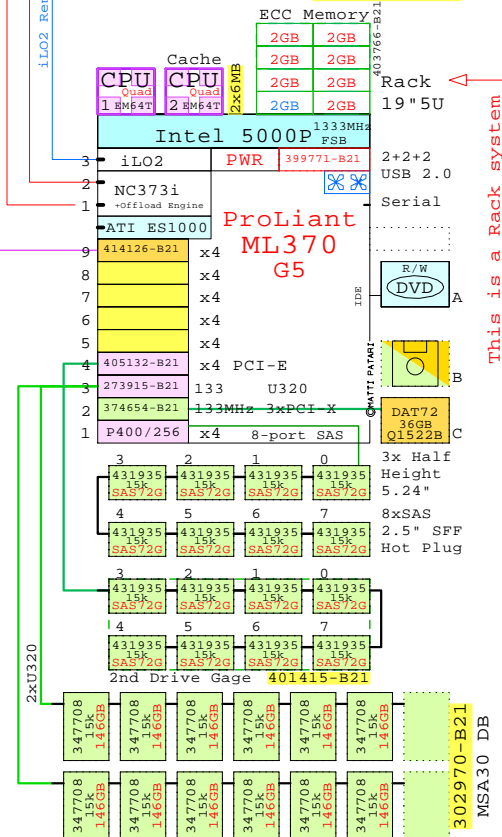

External Two Channel SCSI

Parts list for the Quad-Core E5440 system above

Part Number	Qty	Description
458344-421	1	ML370 G5 1P QC E5440-2x6MB 2GB Rack 5U
1.1	1	273915-B21 Smart Array 6402/128 Ultra320 2-chan
1.2	1	374654-B21 HP Single Ch U320 SCSI HBA
1.3	3	397411-B21 3 HP Blade BL460c Memory 2GB 2x1GB
1.4	1	399771-B21 1 DL380 G5 second power supply WW
1.5	1	400693-B21 1 Hot plug blower kit, ML370 G5
1.6	1	401415-B21 1 2nd Drive Gage 8xSFF SAS ML370 G5
1.6.1	8	431935-B21 8 HP 72GB SAS 15000r hot-plus disk 2.5"
1.7	1	403766-B21 1 Memory Board kit ML370 G5
1.7.1	3	397411-B21 4 HP Blade BL460c Memory 2GB 2x1GB
1.8	1	405132-B21 1 HP Smart Array P400/256 PCI-E HBA
1.9	1	409582-B21 1 Floppy drive kit ML350 G5
1.10	1	414126-B21 1 HP NC510F PCI-E 10-Gigabit Server Adapte
1.11	8	431935-B21 8 HP 72GB SAS 15000r hot-plus disk 2.5"
1.12	1	458412-B21 1 Xeon QC E5440-2x6MB 2830MHz for ML370G5
1.13	1	Q1522B 1 HP DAT 72 36GB internal drive
2	1	302970-B21 1 MSA30 Dual Busg Ultra320 7+7 1"
2.1	12	347708-B21 12 146.8GB 15000r U320 disk 1"

Link to this document:
<http://goldeneggs.spyderbyte.com/geiml370g5x.pdf>

For more detailed configuring, please consult the latest HP QuickSpecs or VisioCafe.com. All trademarks in this document are those of their owners.

2830MHz Dual- or Quad-Core

Intel Xeon E5440 EM64T
2830MHz 1P-Q 458343-421 EU

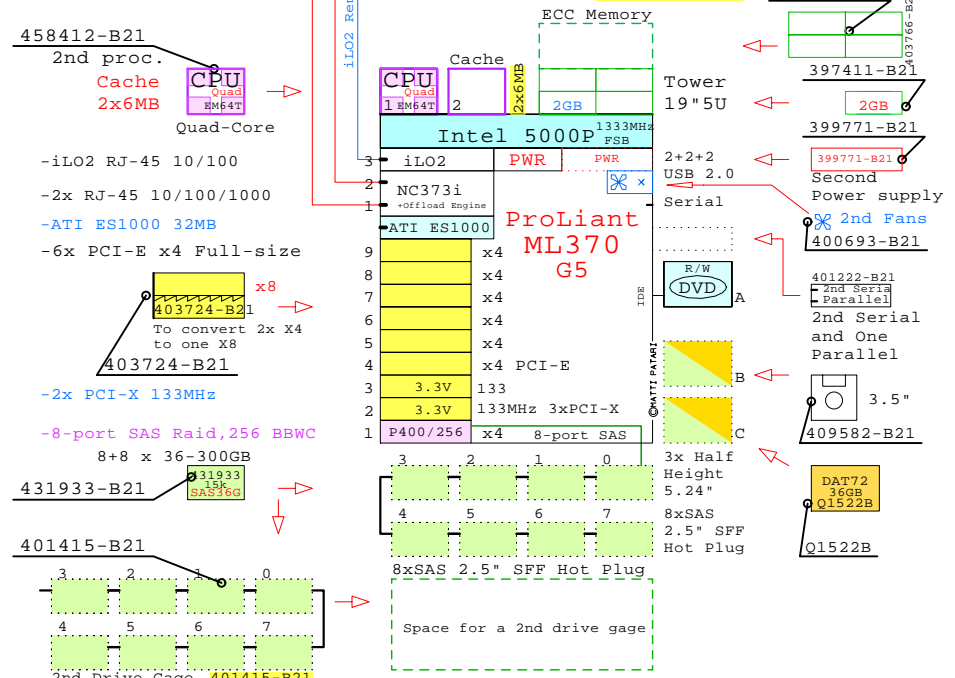

More ML350 G5 systems are serviced on page 2.

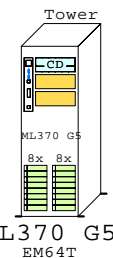
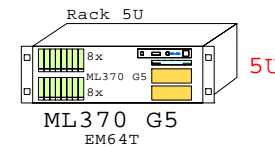
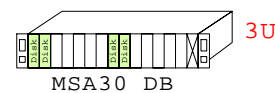

MS Windows Server 2000
 MS Windows Server 2003
 Novell NetWare
 LINUX: Red Hat, SuSE
 VMware Virtualization Software

<http://www.LinuxHPC.org>
<http://www.WinHPC.org>

Golden Eggs home:
<http://goldeneggs.spyderbyte.com/>

© 2008 Matti Patari, All rights reserved.

GOLDEN EGGS Visuals™ Helsinki	18-Jan-2008	GEIML370G5a Matti.Patari@Kolumbus.Fi
-------------------------------	-------------	---

HP ProLiant ML370 G5 E5440 2830MHZ
 GOLDEN EGGS Visuals, Helsinki

2830MHz Dual- or Quad-Core

Intel Xeon E5440 EM64T

Memory Max:
8x8GB=64GB

2830MHz 1P-Q 458343-421 EU

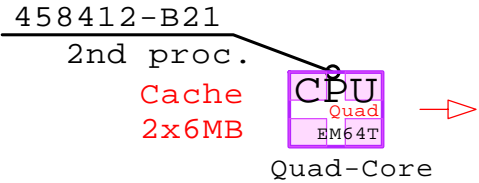
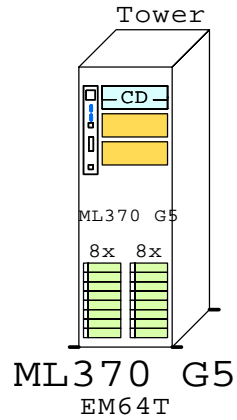

- iLO2 RJ-45 10/100
- 2x RJ-45 10/100/1000
- ATI ES1000 32MB
- 6x PCI-E x4 Full-size

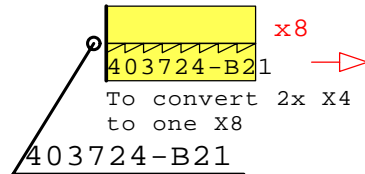

- 2x PCI-X 133MHz
- 8-port SAS Raid, 256 BBWC
- 8+8 x 36-300GB

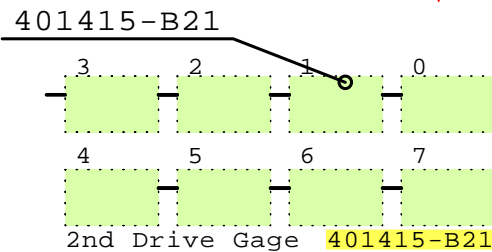
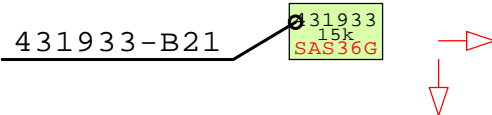

Gigabit E
Gigabit E
iLO2 Remote Manager

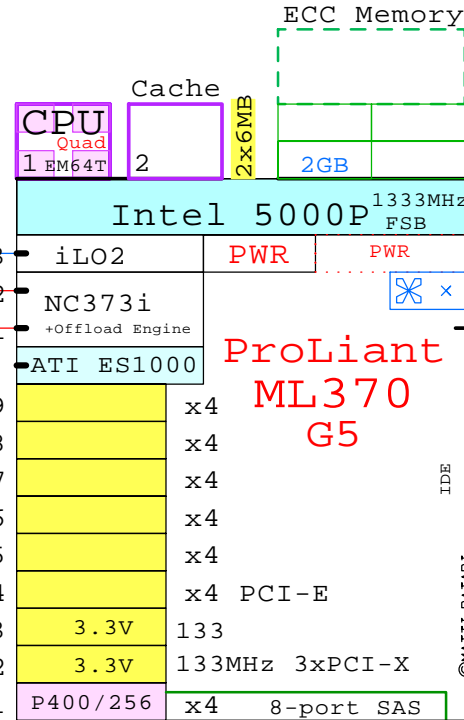

ProLiant
ML370
G5

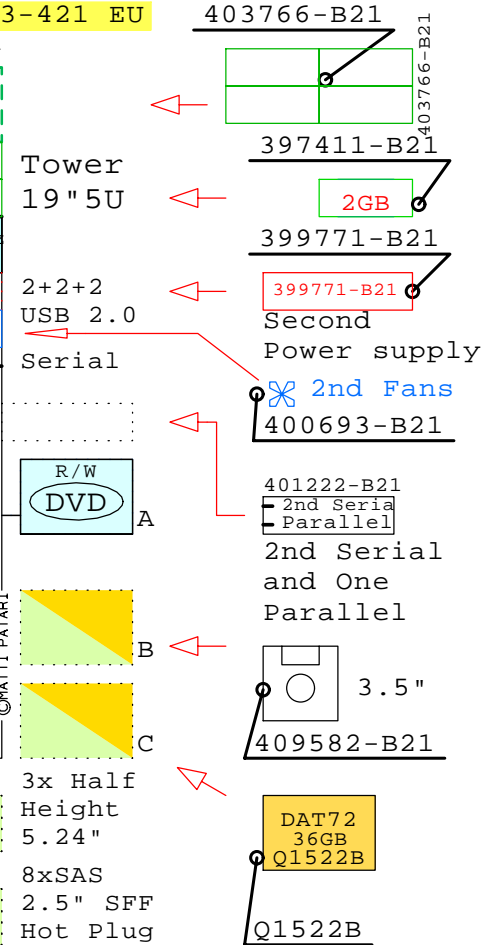

Matti.Patari@Kolumbus.Fi

Golden Eggs home:

<http://goldeneggs.spyderbyte.com/>

Link to this document:

<http://goldeneggs.spyderbyte.com/geggs/GEIML370G5x.pdf>

HP ProLiant ML370 G5 Example Configuration

Intel Xeon E5440 EM64T
2830MHz 1P-Q 458344-421 EU

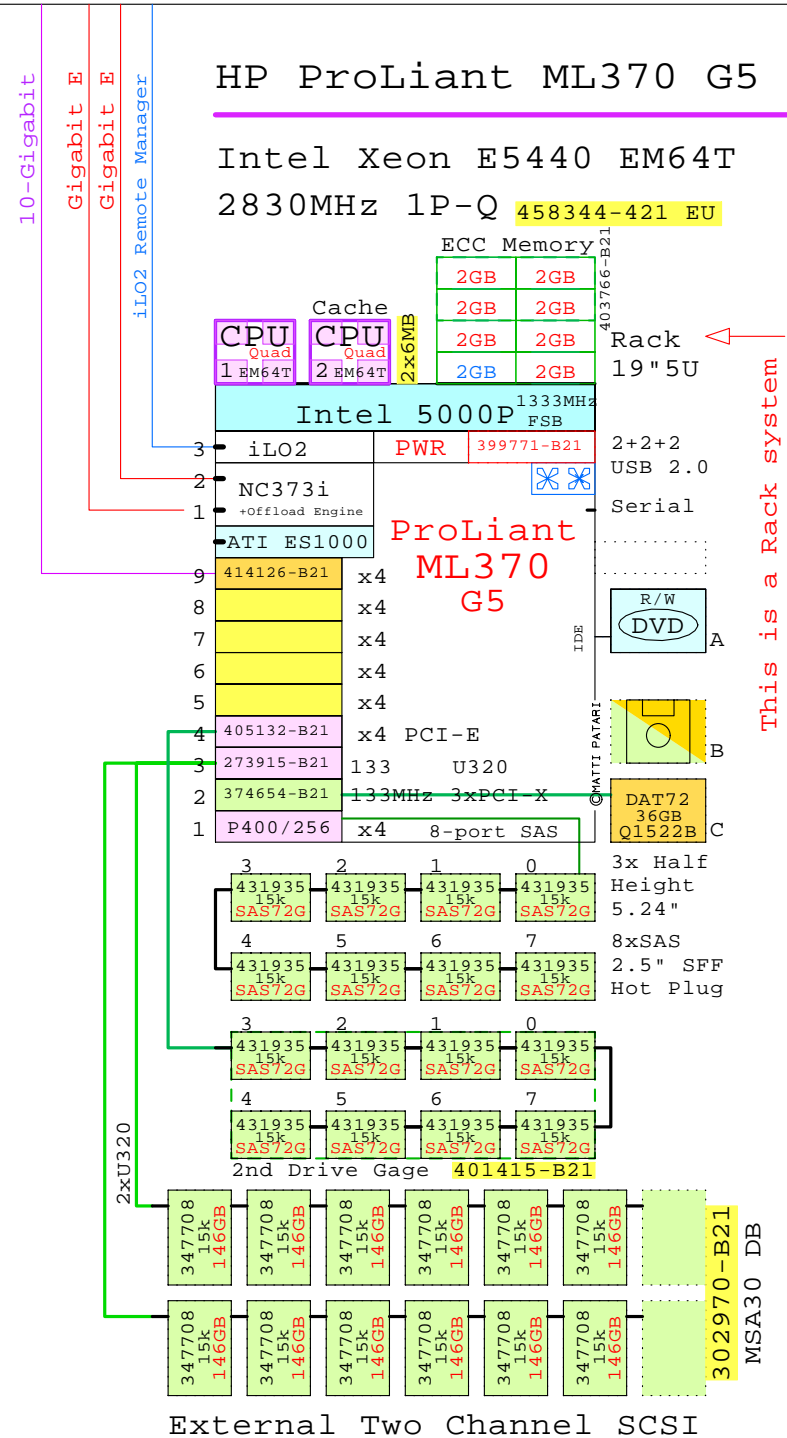

Parts list for the Quad-Core E5440 system above

	Part Number	Qty	Description
1	458344-421	1	ML370 G5 1P QC E5440-2x6MB 2GB Rack 5U
1.1	273915-B21	1	Smart Array 6402/128 Ultra320 2-chan
1.2	374654-B21	1	HP Single Ch U320 SCSI HBA
1.3	397411-B21	3	HP Blade BL460c Memory 2GB 2x1GB
1.4	399771-B21	1	DL380 G5 second power supply WW
1.5	400693-B21	1	Hot plug blower kit, ML370 G5
1.6	401415-B21	1	2nd Drive Gage 8xSFF SAS ML370 G5
1.6.1	431935-B21	8	HP 72GB SAS 15000r hot-plug disk 2.5"
1.7	403766-B21	1	Memory Board kit ML370 G5
1.7.1	397411-B21	4	HP Blade BL460c Memory 2GB 2x1GB
1.8	405132-B21	1	HP Smart Array P400/256 PCI-E HBA
1.9	409582-B21	1	Floppy drive kit ML350 G5
1.10	414126-B21	1	HP NC510F PCI-E 10-Gigabit Server Adapte
1.11	431935-B21	8	HP 72GB SAS 15000r hot-plug disk 2.5"
1.12	458412-B21	1	Xeon QC E5440-2x6MB 2830MHz for ML370G5
1.13	Q1522B	1	HP DAT 72 36GB internal drive
2	302970-B21	1	MSA30 Dual Buss Ultra320 7+7 1"
2.1	347708-B21	12	146.8GB 15000r U320 disk 1"

This is a Rack system

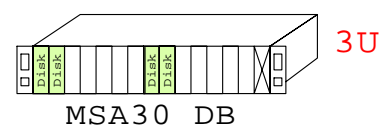
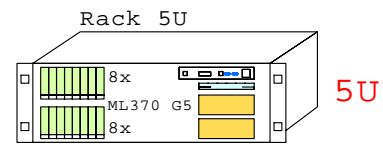

Matti.Patari@Kolumbus.Fi

Golden Eggs home:
<http://goldeneggs.spyderbyte.com/>

Link to this document:
<http://goldeneggs.spyderbyte.com/geggs/GEIML370G5x.pdf>