

Internal Options:

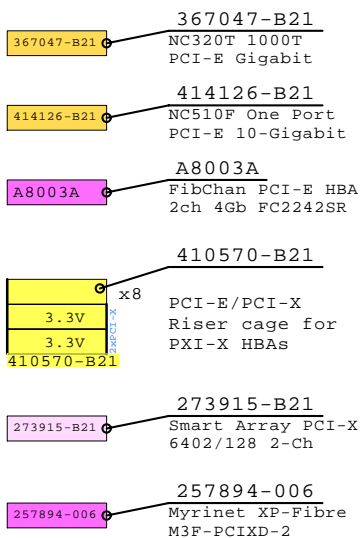

Example Configuration

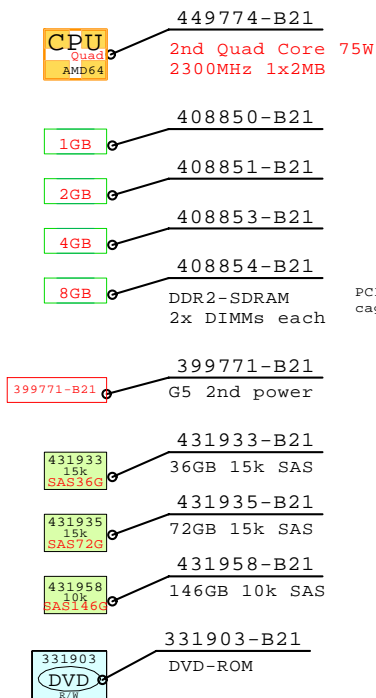
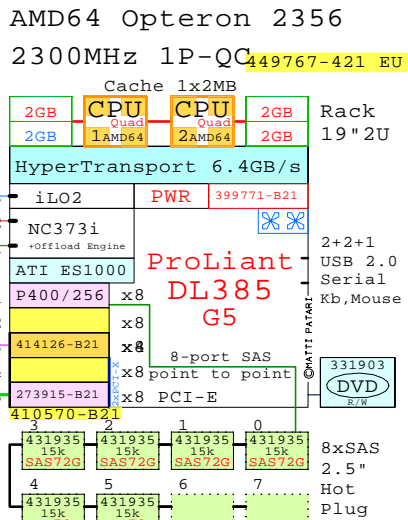

External Two Channel SCSI

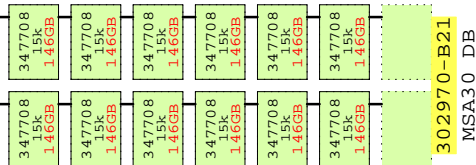

Barcelona

2300MHz Quad Core

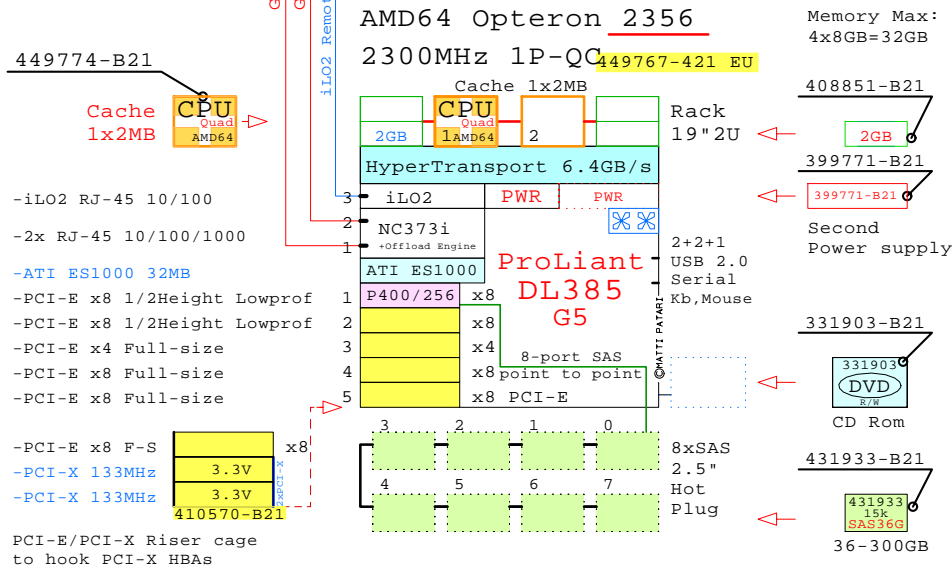

More DL385 G5 systems are serviced on page 2.

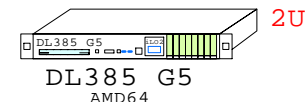
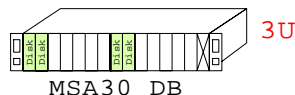

Parts list for the example system above

Part Number	Qty	Description
1	449767-421	1 DL385 G5 1P QC 2356 2.3GH 2GB AMD64 SAS
1.1	331903-B21	1 CD-RW/DVD-ROM Option kit, slimline
1.2	399771-B21	1 DL380 G5 second power supply WW
1.3	408851-B21	3 2GB PC2-5300 DDR2 kit 2x1GB DL385G2
1.4	410570-B21	1 Riser cage PCI-E/PCI-X DL380 G5
1.4.1	273915-B21	1 Smart Array 6402/128 Ultra320 2-chan
1.4.2	414126-B21	1 HP NC510F PCI-E 10-Gigabit Server Adapte
1.5	431935-B21	6 HP 72GB SAS 15000r hot-plug disk 2.5"
1.6	449774-B21	1 Opteron QC 2356-2MB 2300MHz for DL385G5
2	302970-B21	1 MSA30 Dual Buss Ultra320 7+7 1"
2.1	347708-B21	12 146.8GB 15000r U320 disk 1"

Link to the most fresh version of this document:
<http://goldeneggs.spyderbyte.com/geggs/GEODL385G5x.pdf>

MS Windows Server 2003 and 2008
 LINUX: Red Hat, SuSE
 VMware Virtualization Software
 Sun Solaris

<http://www.LinuxHPC.org>
<http://www.WinHPC.org>

Golden Eggs home:
<http://goldeneggs.spyderbyte.com/>

© 2008 Matti Patari, All rights reserved.

GOLDEN EGGS Visuals™ Helsinki	12-Jun-2008	GEODL385G5a
		Matti.Patari@Kolumbus.Fi

HP ProLiant DL385 G5 AMD64 2300MH
 GOLDEN EGGS Visuals, Helsinki

For more detailed configuring, please consult the latest HP QuickSpecs or VisioCafe.com
 All trademarks in this document are those of their owners.

DL385 G5 2P

Barcelona

2300MHz Quad Core

AMD64 Opteron 2356

2300MHz 1P-QC 449767-421 EU

Memory Max:
4x8GB=32GB

449774-B21

Cache
1x2MB



Gigabit E
Gigabit E
iLO2 Remote Manager

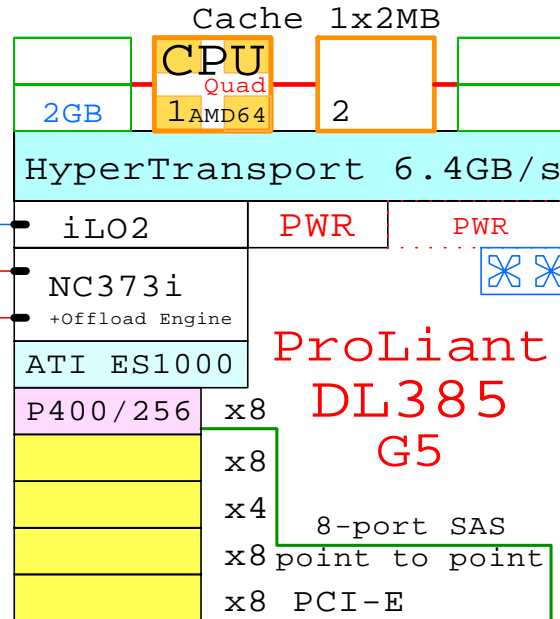

Rack
19" 2U

408851-B21

2GB

399771-B21

399771-B21

Second
Power supply

- iLO2 RJ-45 10/100
- 2x RJ-45 10/100/1000
- ATI ES1000 32MB
- PCI-E x8 1/2Height Lowprof
- PCI-E x8 1/2Height Lowprof
- PCI-E x4 Full-size
- PCI-E x8 Full-size
- PCI-E x8 Full-size

ProLiant
DL385
G5

2+2+1
USB 2.0
Serial
Kb, Mouse

331903-B21



CD Rom

- PCI-E x8 F-S
- PCI-X 133MHz
- PCI-X 133MHz

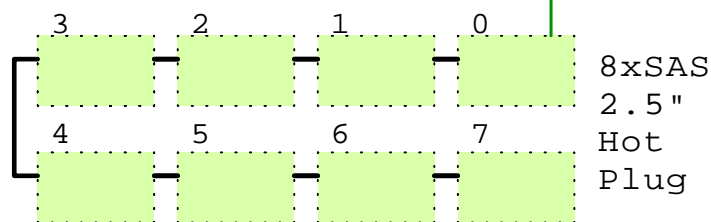
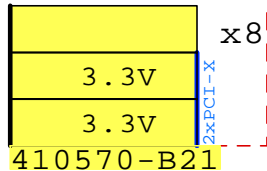

431933-B21

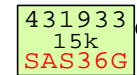

36-300GB

PCI-E/PCI-X Riser cage
to hook PCI-X HBAs



2U

DL385 G5
AMD64

Link to the most fresh version of this document:
<http://goldeneggs.spyderbyte.com/geggs/GEODL385G5x.pdf>

Matti.Patari@Kolumbus.Fi

Golden Eggs home:
<http://goldeneggs.spyderbyte.com/>

Example Configuration

AMD64 Opteron 2356
 2300MHz 1P-QC 449767-421 EU

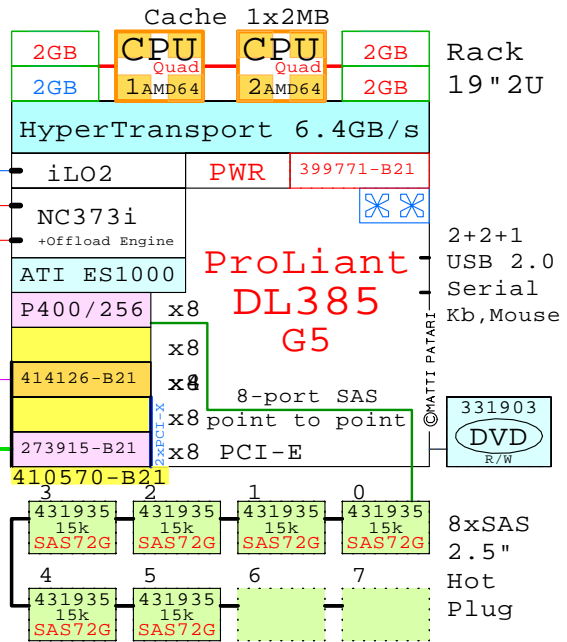

External Two Channel SCSI

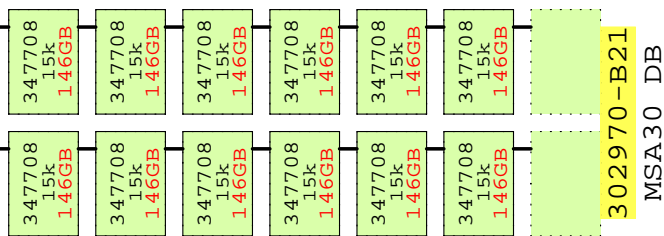

Parts list for the example system above

	Part Number	Qty	Description
1	449767-421	1	DL385 G5 1P QC 2356 2.3GH 2GB AMD64 SAS
1.1	331903-B21	1	CD-RW/DVD-ROM Option kit, slimline
1.2	399771-B21	1	DL380 G5 second power supply WW
1.3	408851-B21	3	2GB PC2-5300 DDR2 kit 2x1GB DL385G2
1.4	410570-B21	1	Riser cage PCI-E/PCI-X DL380 G5
1.4.1	273915-B21	1	Smart Array 6402/128 Ultra320 2-chan
1.4.2	414126-B21	1	HP NC510F PCI-E 10-Gigabit Server Adapte
1.5	431935-B21	6	HP 72GB SAS 15000r hot-plug disk 2.5"
1.6	449774-B21	1	Opteron QC 2356-2MB 2300MHz for DL385G5
2	302970-B21	1	MSA30 Dual Buss Ultra320 7+7 1"
2.1	347708-B21	12	146.8GB 15000r U320 disk 1"

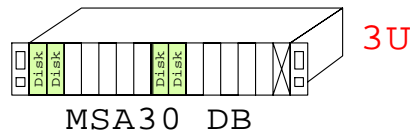
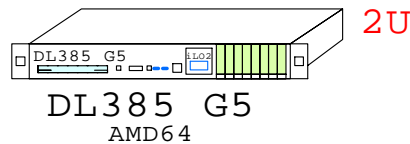

Matti.Patari@Kolumbus.Fi

Golden Eggs home:
<http://goldeneggs.spyderbyte.com/>

Link to the most fresh version of this document:
<http://goldeneggs.spyderbyte.com/geggs/GEODL385G5x.pdf>